

tielbürger

- Ⓓ **Ersatzteilliste Motormäher**
- Ⓕ **Pièces détachées motofaucheuse**
- ⒼⒷ **Spares list sickle bar mower**
- Ⓘ **Lista ricambi falciatrice**
- Ⓝ **Deleliste Motorslåmaskin**

AA-270-040TS

t70

www.tielbuerger.store



Inhalt

Sommaire

Contents

Contenuto

Innhold

Seite
Page
Page
Pagina
Side

Achse _____ 4

Arbre

Axle

Asse

Aksel

Antrieb _____ 6

Transmission

Drive

Trazione

Drift

Gehäuseblock _____ 8

Arbre

Housing

Scatola

Hus

Getriebe _____ 10

Boîte de vitesses

Gear drive

Trasmissione

Gear

www.tielbuenger.store

Lenker _____ 12

Mancheron

Handle bars

Manubrio

Styre

Motorkonsole _____ 14

Embase moteur

Engine plate

Mensola motore

Motorfeste

Taumelgehäuse _____ 16

Boîtier excentrique

Reeling-housing

Scatola eccentrico

Svinghus





Wichtig

Die Spalte „Bemerkung“ hilft Ihnen, Teile zu identifizieren.

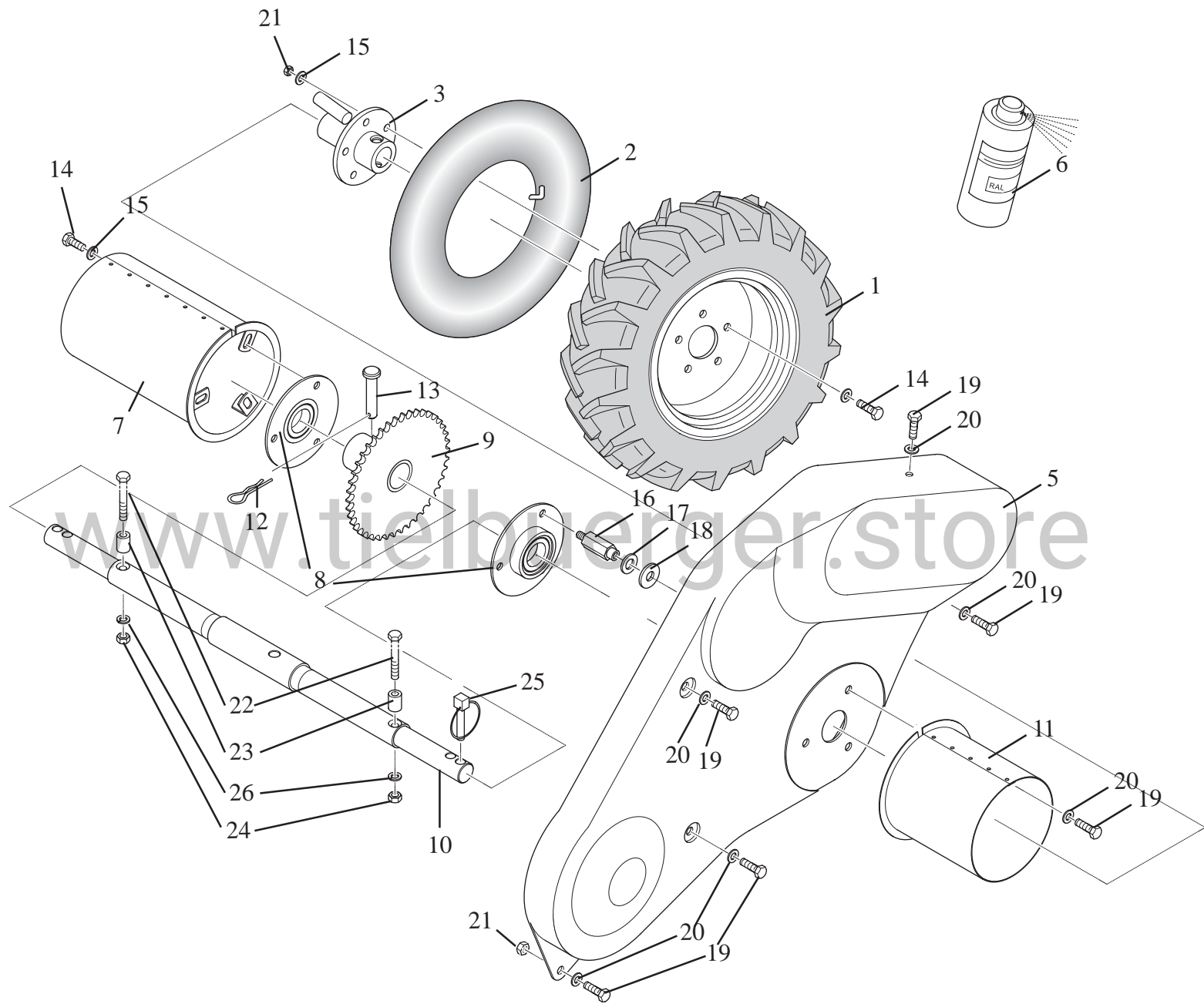



Verwenden Sie ausschließlich Originalersatzteile vom Hersteller. Dadurch wird die sichere Funktion des Gerätes gewährleistet.

Positionsnummern in Klammern sind Verschleißteile.

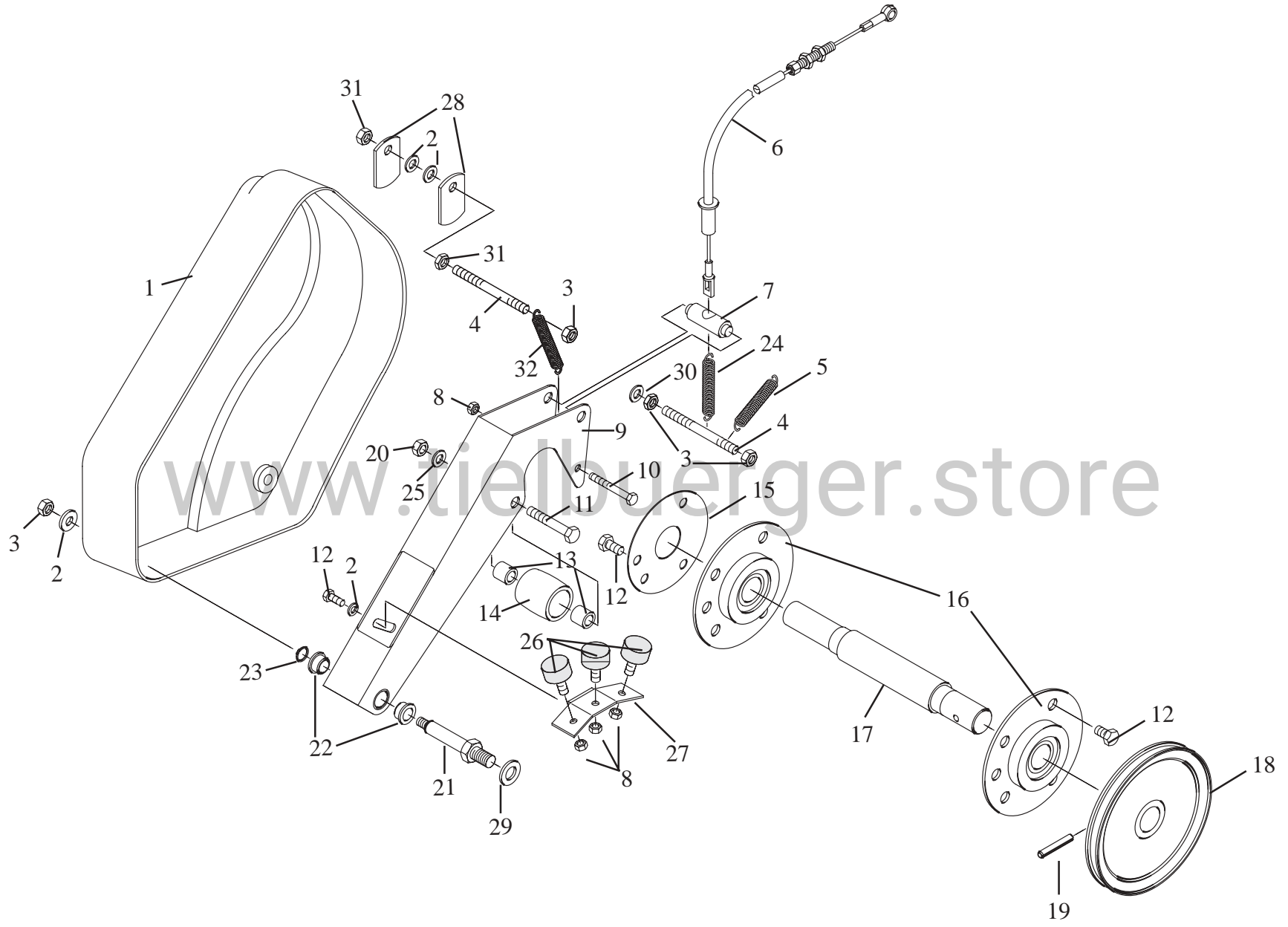





Pos.-Nr. Rep. Pos. Pos. Bilde-Nr.	Bestellnummer Référence Article number Nr. codice Bestillings-Nr.	Anzahl Qté. Quant. Q.tà Antall	Bezeichnung 	Désignation 	Description 	Descrizione 	Benevnelse 	Bemerkungen
(1)	AA-270-058 TS	1	Rad rechts	Roue droite	Wheel right	Ruota dx	Hjul høyre	
(1)	AA-270-057 TS	1	Rad links	Roue gauche	Wheel left	Ruota sx	Hjul venstre	
2	HN-032-008	1	Schlauch	Outre	Tube	Camera aria	Slange	
3	AA-270-144-9010	1	Radnabe					
5	HJ-010-167	1	Keilriemenschutz	Carter de protection	V-belt cover	Protezione cinghia	Kileremsdeksel	
5	HJ-010-175	1	Keilriemenschutz	Carter de protection	V-belt cover	Protezione cinghia	Kileremsdeksel	nur Vanguard
6	KP-002-001	400ml	Farbsprühdose rot	Bombe de peinture rouge	Spray paint tin red	Vernice spray da ritocco rosso	Sprayboks rod	RAL3000
7	AA-270-156-3000	1	Wickelschutz, rechts	Protection anti-enroulement, droite	Coil-protector, right	Protezione, dx	Rør, høyre	
(8)	AA-120-100-9005	2	Flansch	Flasque	Flange	Flangia	Flens	
9	AA-120-146g	1	Kettenrad	Roue de chaîne	Sprocket	Ruota dentata	Kjedehjul	
10	DC-281-0572	1	Achse	Arbre	Axle	Asse	Aksel	
11	AA-270-157-3000	1	Wickelschutz, links	Protection anti-enroulement, gauche	Coil-protector, left	Protezione, sx	Rør, venstre	
(12)	KG-011-001z	1	Federstecker	Support de fiche	Hairpin clip	Spina elastica	Låsesplint	
13	KC-001-033z	1	Splintbolzen	Boulon	Clevis pin	Bullone copiglia	Splintbolt	
14	HO-020-083z	3	Sechskantschraube	Vis à six pans	Hexagon bolt	Vite esagonale	Sekskantskrue	M 8 x20
15	HW-010-007z	13	Scheibe	Rondelle	Washer	Rondella	Skive	B 8,4
16	DV-221-020z	3	Schutzhalter	Support de protecteur	Mounting stud	Supporto protezione	Dekselfest	
17	HW-010-011z	3	Scheibe	Rondelle	Washer	Rondella	Skive	B 13
18	HK-005-027	3	Gummischeibe	Rondelle	Washer	Rondella	Skive	
19	HO-020-082z	7	Sechskantschraube	Vis à six pans	Hexagon bolt	Vite esagonale	Sekskantskrue	M 8 x 16
20	HW-050-007z	7	Scheibe	Rondelle	Washer	Rondella	Skive	Ø8,4
21	HR-010-005z	1	Sechskantmutter	écrou à six pans	Hexagon nut	Dado esagonale	Sekskantmutter	M 8
22	HO-010-090z	2	Sechskantschraube	Vis à six pans	Hexagon bolt	Vite esagonale	Sekskantskrue	M 8 x 55
23	DC-131-018z	2	Hülse	Douille	Spacer tube	Boccola	Hylse	
24	HR-030-005z	2	Sicherungsmutter	écrou de sûreté	Locknut	Dado autobloccante	Låsemutter	M 8
25	AZ-008-004	2	Klappsplint	Goupille	Hinged pin	Spina sicurezza	Orepinne	
26	HT-010-008	2	Federring	Bague de ressort	Spring washer	Anello elastico	Sprengskive	

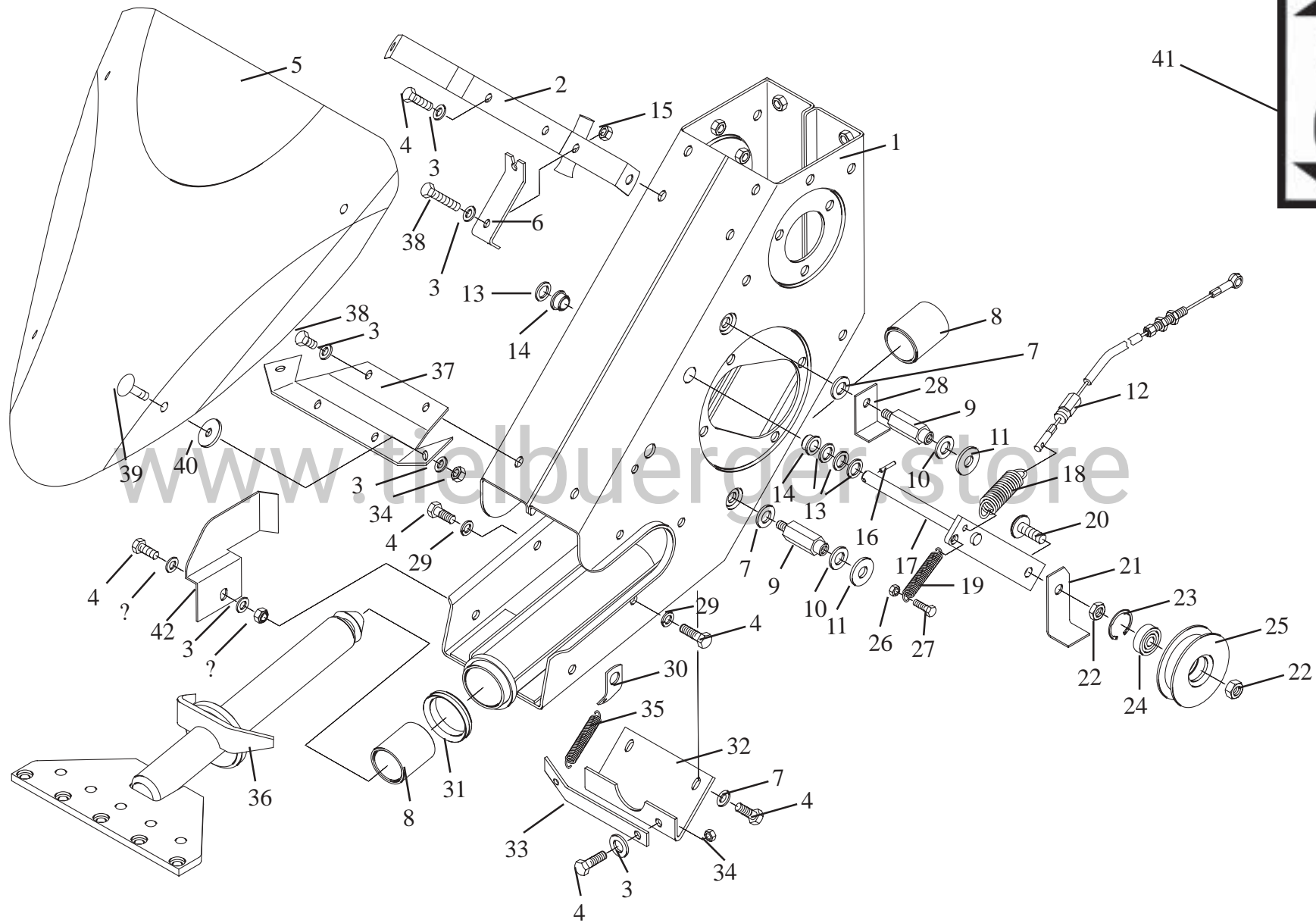





Pos.-Nr. Rep. Pos. Pos. Bilde-Nr.	Bestellnummer Référence Article number Nr. codice Bestillings-Nr.	Anzahl Qté. Quant. Q.tà Antall	Bezeichnung 	Désignation 	Description 	Descrizione 	Benevnelse 	Bemerkungen
1	HJ-010-165	1	Flachriemenschutz	Protecteur de courroie plate	Belt cover	Protezione	Flatremdeksel	
2	HW-010-007z	6	Scheibe	Rondelle	Washer	Rondella	Skive	B 8,4
3	HR-010-005z	5	Sechskantmutter	écrou à six pans	Hexagon nut	Dado esagonale	Sekskantmutter	M8
4	DC-081-013z	2	Bolzen	Boulon	Pin	Bullone	Bolt	
(5)	HI-010-002-9005	1	Zugfeder	Ressort de traction	Extension spring	Molla di trazione	Fjær	
(6)	AZ-007-064	1	Kupplungszug	Commande bowden	Clutch-cable	Cavo frizione	Clutchwire	
7	DC-141-054z	1	Lager	Palier	Bearing	Cuscinetto	Lager	
8	HR-010-004z	4	Sechskantmutter	écrou à six pans	Hexagon nut	Dado esagonale	Sekskantmutter	M6
9	AA-250-143z	1	Flachriemenspanner	Tendeur de courroie plate	Belt tensioner	Tendicinghia	Flatremstrammer	
10	HO-010-061z	1	Sechskantschraube	Vis à six pans	Hexagon bolt	Vite esagonale	Sekskantskrue	M 6 x 50
11	HO-010-120z	1	Sechskantschraube	Vis à six pans	Hexagon bolt	Vite esagonale	Sekskantskrue	M 10 x 55
12	HO-020-082z	7	Sechskantschraube	Vis à six pans	Hexagon bolt	Vite esagonale	Sekskantskrue	M 8 x 16
13	DC-141-016	2	Abstandshülse	Douille d'écartement	Spacer tube	Boccola distanziale	Avstandshylse	
(14)	AZ-002-010	1	Rolle	Galet	pulley	Rullo	Rull	
15	DA-140-267z	1	Scheibe	Rondelle	Washer	Rondella	Skive	
(16)	AL-040-100z	2	Flansch	Flasque	Flange	Flangia	Flens	
17	DC-281-055z	1	Welle	Lame	Shaft	Albero	Aksel	
18	AZ-015-029z	1	Keilriemenscheibe	Poulie	V-belt pulley	Puleggia	Kileremskive	
19	HX-010-240	1	Spannstift	Goupille de serrage	Spring pin	Spina elastica	Spennstift	6,0 x 40
20	HR-010-006z	1	Sechskantmutter	écrou à six pans	Hexagon nut	Dado esagonale	Sekskantmutter	M 10
21	DV-231-006z	1	Lagerbolzen	Entretoise	Bolt	Perno cuscinetto	Lagerbolt	
22	HJ-021-003	2	Bundbuchse	Coussinet	Collar bush	Bussola flangiata	Foring	
23	HU-010-012	1	Sicherungsring	Anneau d'arrêt	Retaining ring	Seger	Semering	
(24)	HI-010-015-9005	1	Zugfeder	Ressort de traction	Extension spring	Molla di trazione	Fjær	
25	HW-010-009z	1	Scheibe	Rondelle	Washer	Rondella	Skive	B10,5
26	HK-001-010	3	Bremsklotz	Bloc de freinage	Brake pad	Ceppo freno	Bremsekloss	
27	AA-260-159z	1	Halter	Support	Stud oder bracket (Flach)	Supporto	Holder	
28	DA-240-401z	2	Führung	Guidage	Guide	Guida	Føring	
29	HW-010-011z	1	Scheibe	Rondelle	Washer	Rondella	Skive	B13
30	HW-050-007z	1	Scheibe	Rondelle	Washer	Rondella	Skive	B8,4
31	HR-020-005z	2	Sechskantmutter	écrou à six pans	Hexagon nut	Dado esagonale	Sekskantmutter	M 8
(32)	HI-010-010z	1	Zugfeder	Ressort de traction	Extension spring	Molla di trazione	Fjær	

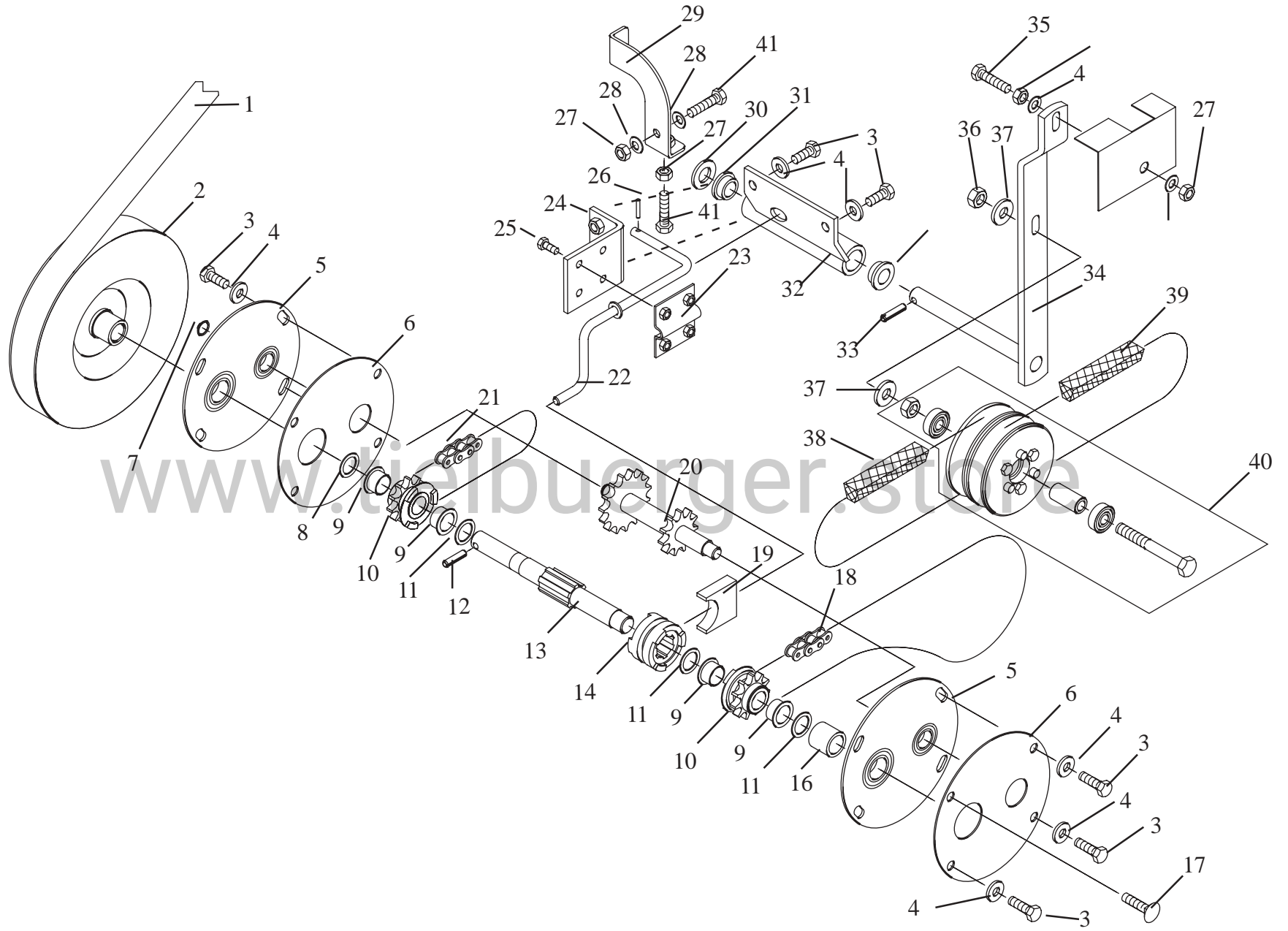

Pos.-Nr. Rep. Pos. Pos. Bilde-Nr.	Bestellnummer Référence Article number Nr. codice Bestillings-Nr.	Anzahl Qté. Quant. Q.tà Antall	Bezeichnung 	Désignation 	Description 	Descrizione 	Benevnelse 	Bemerkungen
1	AA-250-144-9005	1	Gehäuse	Arbre	Housing	Scatola	Hus	
2	AA-250-156-9005	1	Träger oben	Support en haute	Carrier above	Supporto sopra	Holder	
3	HW-010-007z	12	Scheibe	Rondelle	Washer	Rondella	Skive	B 8,4
4	HO-020-083z	12	Sechskantschraube	Vis à six pans	Hexagon bolt	Vite esagonale	Sekskantskrue	M 8 x 20
5	HJ-010-170	1	Haube	Chapeau	Hood oder cover (auch hart)	Cofano	Deksel	
6	DA-240-384-9005	1	Halter	Support	Stud oder bracket (Flach)	Supporto	Holder	
7	HW-050-007z	4	Scheibe	Rondelle	Washer	Rondella	Skive	8,4
8	HJ-051-005	2	Buchse	Coussinet	Bush	Boccola	Foring	
9	DV-221-020z	2	Schutzhalter	Support de protecteur	Mounting stud	Supporto protezione	Dekselfeste	
10	HW-010-011z	2	Scheibe	Rondelle	Washer	Rondella	Skive	B13
11	HK-005-027	2	Scheibe	Rondelle	Washer	Rondella	Skive	
12	AZ-007-062	1	Kupplungszug	Commande bowden	Clutch-cable	Cavo frizione	Clutchwire	
13	HW-020-011z	4	Scheibe	Rondelle	Washer	Rondella	Skive	13
14	HJ-021-003	2	Bundbuchse	Coussinet	Collar bush	Bussola flangiata	Foring	
15	HR-010-005z	5	Sechskantmutter	écrou à six pans	Hexagon nut	Dado esagonale	Sekskantmutter	M 8
16	HZ-010-076z	1	Splint	Goupille	Cotter pin	Copiglia	Splint	3,2 x 20
17	AA-250-145z	1	Keilriemenspanner	Tendeur de courroie	V-belt tensioner	Tendicinghia	Kileremstrammer	
18	HI-010-015-9005	1	Zugfeder	Ressort de traction	Extension spring	Molla di trazione	Fjær	
19	HI-010-010z	1	Zugfeder	Ressort de traction	Extension spring	Molla di trazione	Fjær	
20	KC-001-080z	1	Flachrundschaube	Vis à tête bombée	Cut head bolt	Vite testa tonda	Flatrundskrue	M 10 x 35
21	DA-200-658z	1	Führung	Guidage	Guide	Guida	Føring	
22	HR-010-006z	2	Sechskantmutter	écrou à six pans	Hexagon nut	Dado esagonale	Sekskantmutter	M 10
23	HU-020-030	1	Sicherungsring	Anneau d'arrêt	Retaining ring	Sejer	Semering	
(24)	HA-030-021	1	Kugellager	Roulement à billes	Ball bearing	Cuscinetto a sfere	Kulelager	
25	AZ-002-108-9005	1	Spannrolle	Galet tendeur	Tensioning pulley	Rullo tenditore	Strammerull	
26	HR-010-004z	1	Sechskantmutter	écrou à six pans	Hexagon nut	Dado esagonale	Sekskantmutter	M 6
27	HO-020-055z	1	Sechskantschraube	Vis à six pans	Hexagon bolt	Vite esagonale	Sekskantskrue	M 6 x 20
28	DA-200-672z	1	Winkel	Equerre	Slide	Angolare	Vinkel	
29	HT-010-008	6	Federring	Bague de ressort	Spring washer	Anello elastico	Sprengskive	A 8
30	DA-200-373	1	Lasche	Tirant	Tongue	Staffa	Feste	
31	HL-002-026	1	V-Ring	Bague	Ring	Anello	Ring	NBR
32	DA-240-387z	1	Halteblech	Tôle d'arrêt	Mounting plate	Lamiera supporto	Holder	
33	DB-180-016z	1	Arretierung	Barrière	Arrestor	Bloccaggio	Lås	
34	HR-030-005z	6	Sicherungsmutter	écrou de sûreté	Locknut	Dado autobloccante	Låsemutter	M 8
35	HI-010-010z	1	Zugfeder	Ressort de traction	Extension spring	Molla di trazione	Fjær	
36	AZ-005-012-9005	1	Tragzapfen	Tourillon d'arbre	Carrying pivot	Perno trascinamento	Bjelketapp	
37	DA-240-390-9005	1	Träger unten	Support en bas	Carrier below	Supporto giù	Holder	
38	HO-020-082z	3	Sechskantschraube	Vis à six pans	Hexagon bolt	Vite esagonale	Sekskantskrue	M 8 x 16
39	HP-056-083z	4	Flachrundschaube	Vis à tête bombée	Cut head bolt	Vite testa tonda	Flatrundskrue	M 8 x 20
40	HW-060-007z	4	Scheibe	Rondelle	Washer	Rondella	Skive	B8,4
41	KD-003-022	1	Aufkleber	Autocollant	Lable	Autoadesivo	Dekal	
42	DA-200-691-9005	1	Seitenblech	Tôle	Mounting shield	Cofano laterale	Sidedeksel	



Pos.-Nr. Rep. Pos. Pos. Bilde-Nr.	Bestellnummer Référence Article number Nr. codice Bestillings-Nr.	Anzahl Qté. Quant. Q.tà Antall	Bezeichnung 	Désignation 	Description 	Descrizione 	Benevnelse 	Bemerkungen
(1)	HC-010-049	1	Flachriemen	Courroie plate	Belt	Cinghia piana	Flatrem	
2	AA-250-142z	1	Flachriemenscheibe	Poulie	Belt rim	Puleggia cinghia piana	Flatremskive	
3	HO-020-083z	10	Sechskantschraube	Vis à six pans	Hexagon bolt	Vite esagonale	Sekskantskrue	M 8 x 20
4	HW-050-007z	11	Scheibe	Rondelle	Washer	Rondella	Skive	Ø 8,4
5	AA-250-058TS	2	Doppelflansch	Flasque double	Double flange	Flangia doppia	Flens dobbel	
6	DA-180-127z	2	Flansch	Flasque	Flange	Flangia	Flens	
7	HU-010-012	1	Sicherungsring	Anneau d'arrêt	Retaining ring	Sejer	Semering	A 12 x 1,0
8	HW-080-115	1	Paßscheibe	Rondelle	Shaft spacer	Anello distanziale	Skive	18x 25x 0,5
(9)	HJ-021-008	4	Buchse	Coussinet	Bush	Boccola	Foring	
10	HE-020-014e	2	Kettenrad	Roue de chaîne	Sprocket	Ruota dentata	Kjedehjul	
11	HW-080-106	3	Paßscheibe	Rondelle	Shaft spacer	Anello distanziale	Skive	18 x 25 x 1
12	HX-010-235	1	Spannstift	Goupille de serrage	Spring pin	Spina elastica	Spennstift	6,0 x 26
13	DC-234-008	1	Welle	Lame	Shaft	Albero	Aksel	
14	DC-394-007e	1	Schaltklaue	Griffe	Shifting claw	Innesto di comando	Koblingsklo	
15	HO-020-085z	2	Sechskantschraube	Vis à six pans	Hexagon bolt	Vite esagonale	Sekskantskrue	M 8 x 30
16	DC-231-053z	1	Hülse	Douille	Spacer tube	Boccola	Hylse	
17	HO-209-084z	1	Linsenschraube	Vis	Screw	Vite lamiera	Skruer	M 8 x 25
(18)	HD-030-007	1	Rollenkette	Chaîne à rouleaux	Roller chain	Catena a rullini	Kjede	
(19)	HJ-010-061	1	Schaltgabel	Fourche d'embrayage	Selector fork	Forcella innesto	Koblingsgaffel	
20	AA-270-143-9005	1	Welle	Lame	Shaft	Albero	Aksel	
(21)	HD-030-004	1	Rollenkette	Chaîne à rouleaux	Roller chain	Catena a rullini	Kjede	
22	AA-270-148z	1	Schalthebel	Levier d'embrayage	Shifting lever	Leva comando	Girstang	
23	AA-270-150z	1	Führung	Guidage	Guide	Guida	Føring	
24	AA-270-141-9005	1	Winkel	Equerre	Slide	Angolare	Vinkel	
25	HO-020-054z	4	Sechskantschraube	Vis à six pans	Hexagon bolt	Vite esagonale	Sekskantskrue	M 6 x 16
(26)	KG-011-001z	1	Federstecker	Support de fiche	Hairpin clip	Spina elastica	Låsesplint	Ø 2,5
27	HR-010-005z	3	Sechskantmutter	écrou à six pans	Hexagon nut	Dado esagonale	Sekskantmutter	M 8
(28)	HI-040-010	2	Tellerfeder	Ressort	Belleville washer	Molla tazza	Fjærskive	
29	AA-270-149z	1	Hebel	Levier	Lever	Leva	Handel	
30	HW-010-013z	1	Scheibe	Rondelle	Washer	Rondella	Skive	Ø 15
(31)	HJ-021-007	2	Bundbuchse	Coussinet	Collar bush	Bussola flangiata	Foring	
32	AA-270-145-9005	1	Lagerbock	Logement	Bearing housing	Scatola cuscinetto	Lagerhus	
33	HX-010-236	1	Spannstift	Goupille de serrage	Spring pin	Spina elastica	Spennstift	
34	AA-270-146-9005	1	Verstellhebel	Levier de réglage	Adjusting lever	Leva di regolazione	Stillehendel	
35	HO-020-085z	1	Sechskantschraube	Vis à six pans	Hexagon bolt	Vite esagonale	Sekskantskrue	M 8 x 30
36	HR-010-006z	1	Sechskantmutter	écrou à six pans	Hexagon nut	Dado esagonale	Sekskantmutter	
37	HW-050-009z	2	Scheibe	Rondelle	Washer	Rondella	Skive	Ø 10,5
38	HB-200-014	1	Spezialkeilriemen	Courroie spéciale	Special V-belt	Cinghia speciale	Kilerem spesial	
39	HB-200-021	1	Spezialkeilriemen	Courroie spéciale	Special V-belt	Cinghia speciale	Kilerem spesial	nur Yamaha
39	HB-200-013	1	Spezialkeilriemen	Courroie spéciale	Special V-belt	Cinghia speciale	Kilerem spesial	
40	AA-270-051TS	1	Variator					
41	HO-020-084z	2	Sechskantschraube	Vis à six pans	Hexagon bolt	Vite esagonale	Sekskantskrue	M 8 x 25
42	DA-140-438	1	Schutzblech	Tôle de sécurité	Protecting sheet	Lamierino protezione	Deksel	



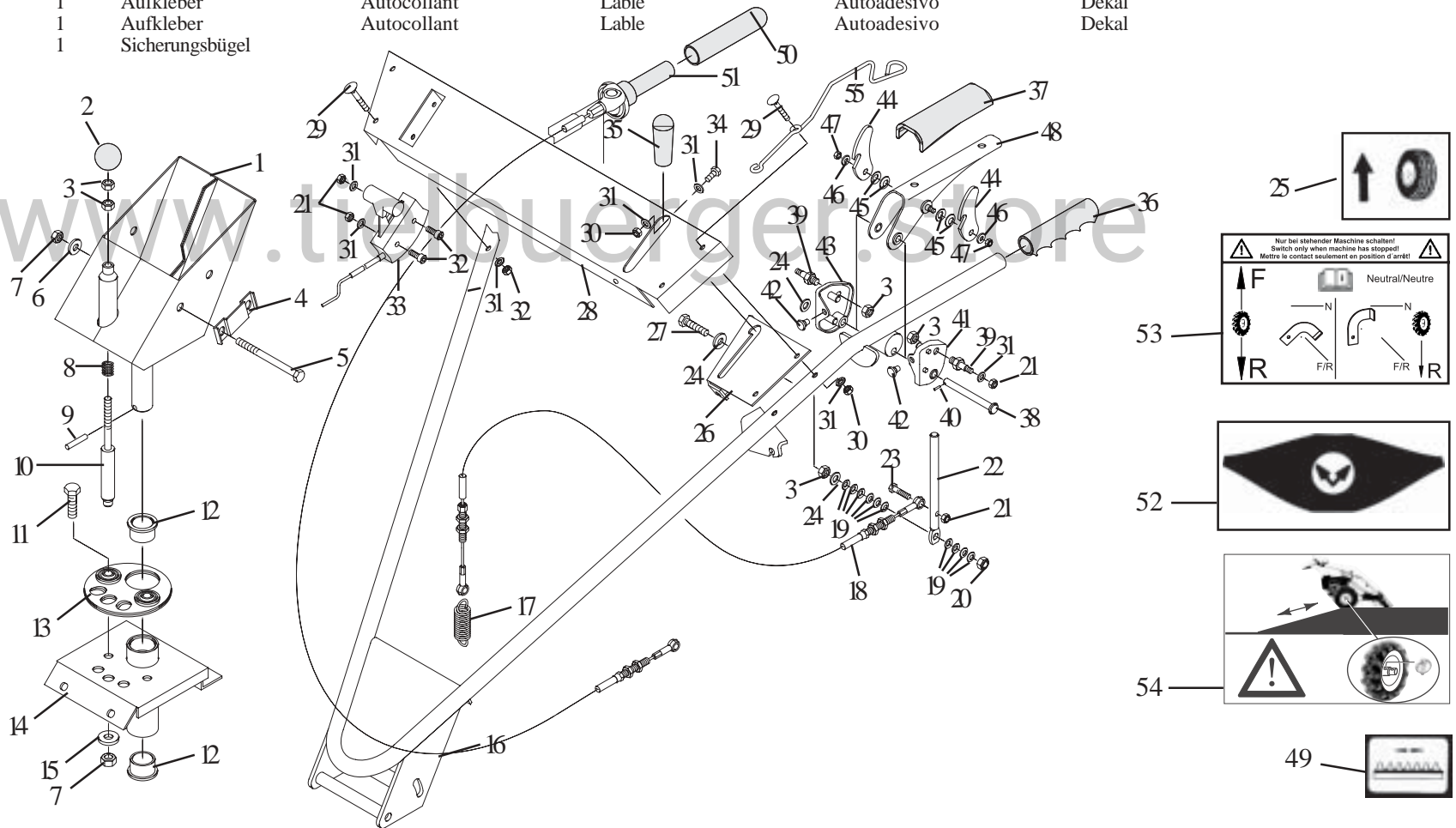

Pos.-Nr. Rep. Pos. Bilde-Nr.	Bestellnummer Référence Article number Nr. codice Bestillings-Nr.	Anzahl Qté. Quant. Q.tà Antall	Bezeichnung D	Désignation F	Description GB	Descrizione I	Benevnelse N	Bemerkungen
1	AA-250-140-3000	1	Lenkerturm	Guidon pivotant	Handle bars support	Piantone manubrio	Styre	
2	HJ-010-025	1	Kugelgriff	Pommeau	Ball grip	Pomello	Kule	
3	HR-010-005z	5	Sechskantmutter	écrou à six pans	Hexagon nut	Dado esagonale	Sekskantmutter	M 8
4	DA-200-663z	1	Haltelasche	Tirant	Tongue	Staffa	Feste	
5	HO-010-132z	2	Sechskantschraube	Vis à six pans	Hexagon bolt	Vite esagonale	Sekskantskrue	M 10 x 150
6	HW-050-009z	2	Scheibe	Rondelle	Washer	Rondella	Skive	Ø10,5
7	HR-010-006z	4	Sechskantmutter	écrou à six pans	Hexagon nut	Dado esagonale	Sekskantmutter	M 10
8	HI-020-001z	1	Druckfeder	Ressort de pression	Compression spring	Molla di compressione	Fjær	
(9)	HX-010-238	1	Spannstift	Goupille de serrage	Spring pin	Spina elastica	Spennstift	6 x 32
10	DC-141-055z	1	Rastbolzen	Boulon d'encliquetage	Positioning bolt	Perno arresto	Bolt	
11	HO-020-115z	2	Sechskantschraube	Vis à six pans	Hexagon bolt	Vite esagonale	Sekskantskrue	M 10 x 30
12	HJ-021-004	2	Bundbuchse	Coussinet	Collar bush	Bussola flangiata	Foring	
13	AA-120-191-9005	1	Schwingungsdämpfer	Amortisseur	Vibration damper	Ammortizzatore	Dempeskive	
14	AA-250-141-9005	1	Lenkerträger	Support de mancheron	Carrier	Support (Manubrio)	Holder (Styre)	
15	HW-010-009	2	Scheibe	Rondelle	Washer	Rondella	Skive	Ø10,5
16	AA-260-147-9010	1	Lenker	Mancheron	Handle bars	Manubrio	Styre	
17	HI-010-024-9005	1	Zugfeder	Ressort de traction	Extension spring	Molla di trazione	Fjær	
18	AZ-007-065	1	Kupplungszug	Commande bowden	Clutch-cable	Cavo frizione	Clutchwire	
19	HI-040-009	10	Tellerfeder	Ressort	Belleville washer	Molla tazza	Fjærskive	
20	HR-030-005z	1	Sicherungsmutter	écrou de sûreté	Locknut	Dado autobloccante	Låsemutter	M 8
21	HR-030-004z	1	Sicherungsmutter	écrou de sûreté	Locknut	Dado autobloccante	Låsemutter	M 6
22	DC-081-014z	1	Hebel	Levier	Lever	Leva	Hendel	
23	HO-020-056z	1	Sechskantschraube	Vis à six pans	Hexagon bolt	Vite esagonale	Sekskantskrue	M 6 x 25
24	HW-010-007z	3	Scheibe	Rondelle	Washer	Rondella	Skive	Ø 8,4
25	KD-003-051	1	Aufkleber	Autocollant	Lable	Autoadesivo	Dekal	
26	DA-200-660z	1	Schaltblende	Blende	Shifting board	Mascherina comandi	Deksel	
27	HO-020-087z	1	Sechskantschraube	Vis à six pans	Hexagon bolt	Vite esagonale	Sekskantskrue	M 8 x 40
28	DA-200-655-3000	1	Lenkerkonsole	Embase de mancheron	Handle bars bracket	Mensola manubrio	Feste av styret	
29	HO-032-059z	4	Flachrundschrabe	Vis à tête bombée	Cut head bolt	Vite testa tonda	Flatrundskrue	M 6 x 40
30	HR-010-004z	5	Sechskantmutter	écrou à six pans	Hexagon nut	Dado esagonale	Sekskantmutter	M 6
31	HW-010-004z	8	Scheibe	Rondelle	Washer	Rondella	Skive	Ø6,4
32	HO-040-054z	2	Zylinderschraube	Vis	Screw	Vite	Skrue	M 6 x 16
33	AZ-006-086	1	Gashebel	Accélérateur	Throttle lever	Leva gas	Gasshendel	
33	AZ-006-102	1	Gashebel	Accélérateur	Throttle lever	Leva gas	Gasshendel	nur Yamaha
33	AZ-006-103	1	Gashebel	Accélérateur	Throttle lever	Leva gas	Gasshendel	nur Vanguard
34	HO-020-054z	1	Sechskantschraube	Vis à six pans	Hexagon bolt	Vite esagonale	Sekskantskrue	M 6 x 16
(35)	HJ-010-171	1	Griff	Poignée	Handle	Leva	Handtak	
36	HJ-010-018	1	Griff	Poignée	Handle	Leva	Handtak	
(37)	HJ-010-077	1	Griff	Poignée	Handle	Leva	Handtak	
38	KC-001-041z	1	Splintbolzen	Boulon	Clevis pin	Bullone copiglia	Splintbolt	
39	DV-181-005z	2	Anschlußbolzen	Boulon	Coupling pin	Perno collegamento	Bolt	
40	HZ-010-041z	1	Splint	Goupille	Cotter pin	Copiglia	Splint	
41	AA-140-342	1	Schaltstück links	Pièce de contact, gauche	Shifting plate left	Rinvio comando sx	Sjaltestykke, venstre	
42	HK-005-010	2	Zargenpuffer	Tampon d'encadrement	Rubber stop	Tampone telaio	Demper	
43	AA-140-341	1	Schaltstück rechts	Pièce de contact, droit	Shifting plate right	Rinvio comando dx	Sjaltestykke, høyre	

Pos.-Nr. Rep. Pos. Bilde-Nr.	Bestellnummer Référence Article number Nr. codice Bestillings-Nr.	Anzahl Qté. Quant. Q.tà Antall	Bezeichnung (D)	Désignation (F)	Description (GB)	Descrizione (I)	Benevnelse (N)	Bemerkungen
---------------------------------------	---	--	--------------------	--------------------	---------------------	--------------------	-------------------	-------------

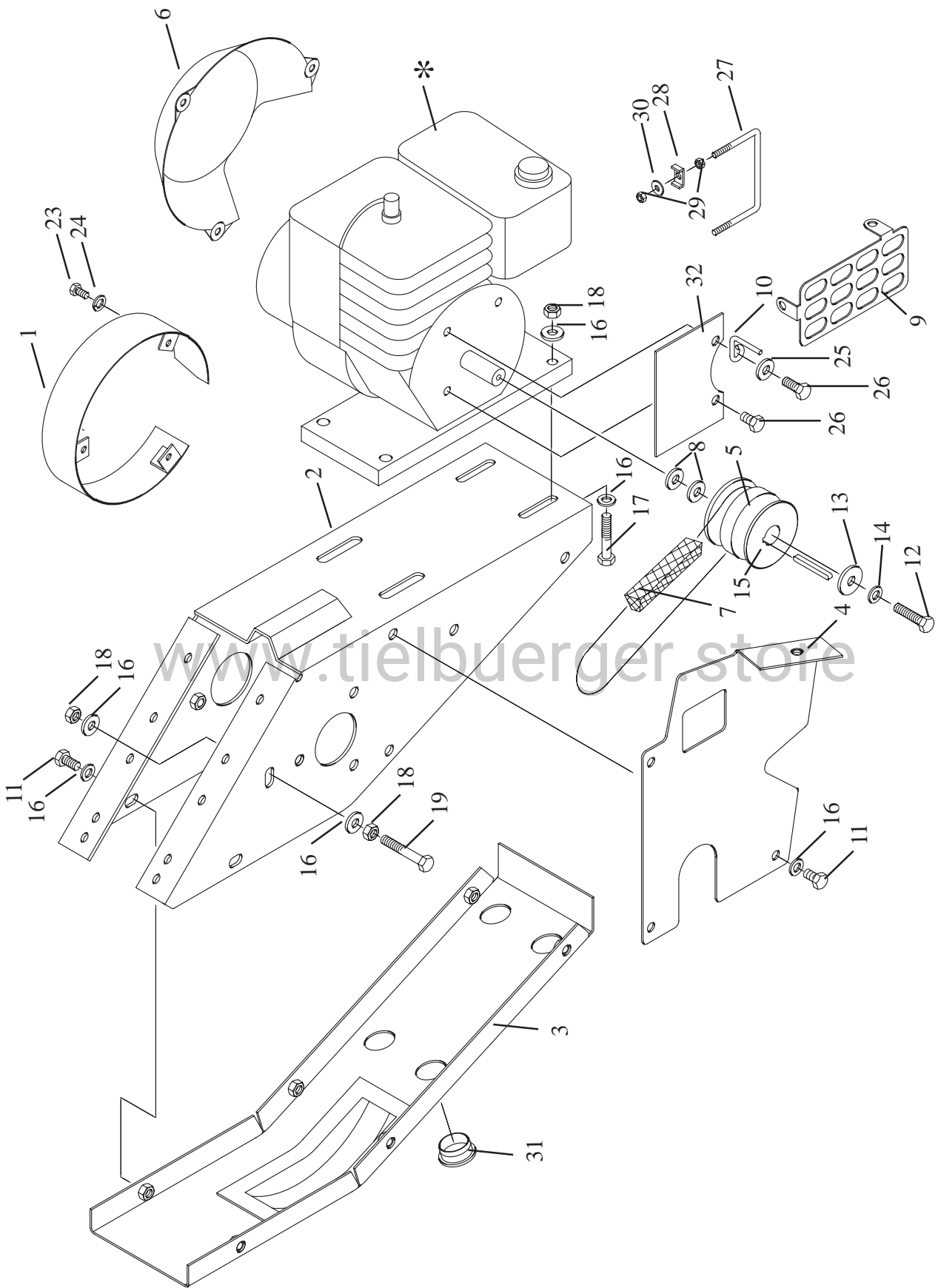
44	DA-292-030	2	Klinke	Clenche	Coupling link	Arresto	Klinke	
45	HI-040-010	4	Tellerfeder	Ressort	Belleville washer	Molla tazza	Fjærskive	
46	HW-050-002z	2	Scheibe	Rondelle	Washer	Rondella	Skive	
47	HR-030-003z	2	Sicherungsmutter	écrou de sûreté	Locknut	Dado autobloccante	Låsemutter	M 5
48	AA-140-340	1	Schaltgriff	Manche d'embrayage	Shifting grip	Manopola innesto	Koblingshandtak	
49	KD-003-048	1	Aufkleber	Autocollant	Lable	Autoadesivo	Dekal	
50	HJ-010-172	1	Griff	Poignée	Handle	Leva	Handtak	
51	AZ-007-066	1	Drehgriff 7-Gang					
52	KD-003-097	1	Aufkleber	Autocollant	Lable	Autoadesivo	Dekal	
53	KD-003-082	1	Aufkleber	Autocollant	Lable	Autoadesivo	Dekal	
54	KD-003-098	1	Aufkleber	Autocollant	Lable	Autoadesivo	Dekal	
55	HI-040-030z	1	Sicherungsbügel					







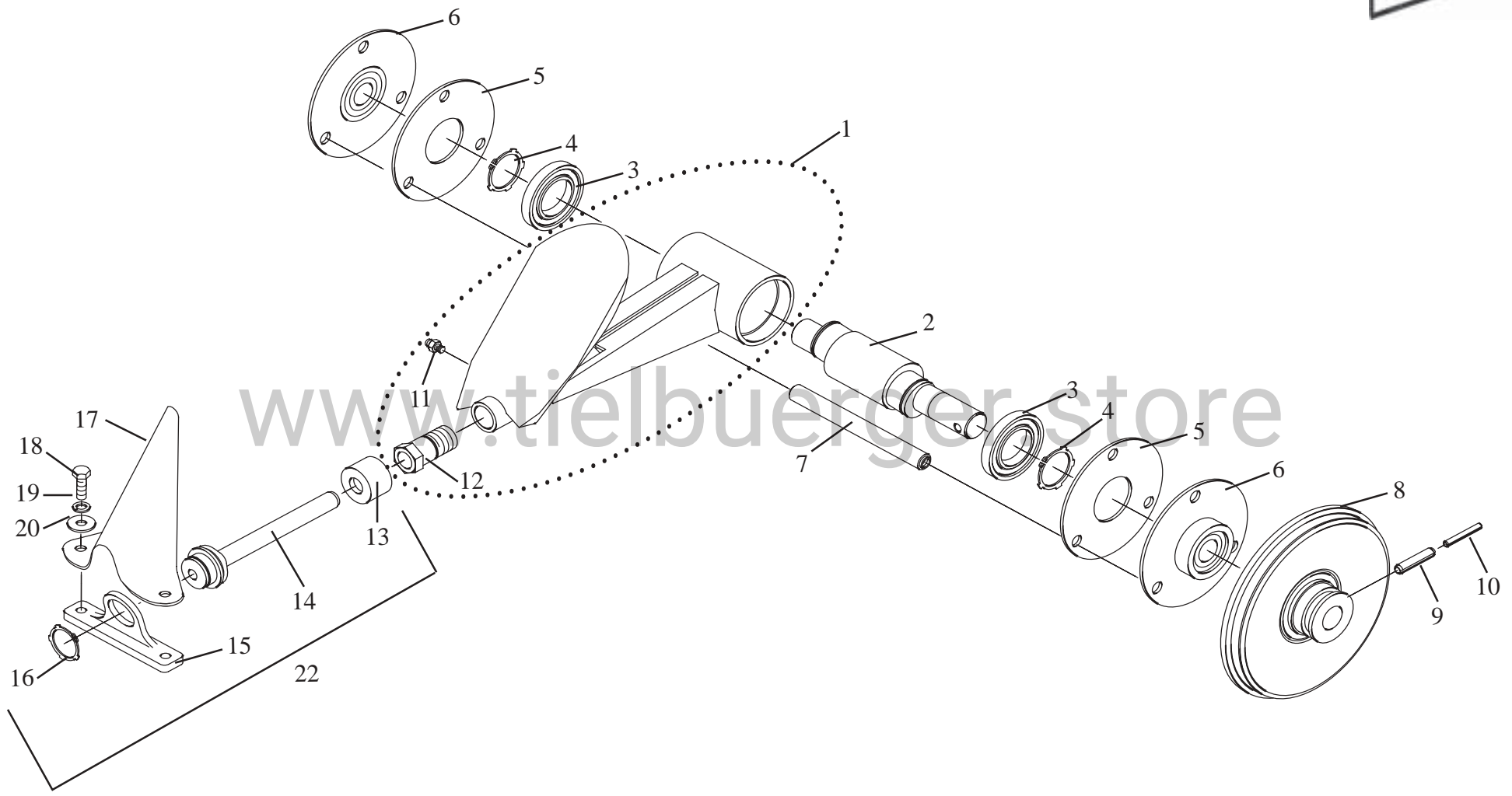
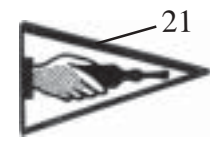

Pos.-Nr. Rep. Pos. Pos. Bilde-Nr.	Bestellnummer Référence Article number Nr. codice Bestillings-Nr.	Anzahl Qté. Quant. Q.tà Antall	Bezeichnung 	Désignation 	Description 	Descrizione 	Benevnelse 	Bemerkungen
1	AA-260-158-9005	1	Motorwickelschutz	Bande pare-moteur	Cover	Protezione motore	Beskyttelse	nur Vanguard
1	AA-021-140-9005	1	Motorwickelschutz	Bande pare-moteur	Cover	Protezione motore	Beskyttelse	nur Kawasaki
2	AA-250-152-9005	1	Motorconsole	Embase moteur	Engine plate	Mensola motore	Motorfeste	
3	AA-250-148-9005	1	Bodenblech	Fond en tôle	Bottom plate	Lamierino	Deksel	
4	AA-270-142-9005	1	Seitenschutz	Protecteur	Protection oder Cover	Protezione	Deksel	
5	DX-001-085e	1	Keilriemenscheibe	Poulie	V-belt pulley	Puleggia	Kileremskive	nur Honda
5	DX-001-086e	1	Keilriemenscheibe	Poulie	V-belt pulley	Puleggia	Kileremskive	nur B&S, Kawasaki
5	DX-001-089e	1	Keilriemenscheibe	Poulie	V-belt pulley	Puleggia	Kileremskive	nur Yamaha
6	DA-140-426z	1	Ansaugschutz	Protecteur	Protection	Protezione	Deksel	nur Honda
7	HB-070-273	1	Spezial-Keilriemen	Courroie spéciale	Special V-belt	Cinghia speciale	Kilerem spesial	
7	HB-070-285	1	Spezial-Keilriemen	Courroie spéciale	Special V-belt	Cinghia speciale	Kilerem spesial	nur Yamaha
8	HW-010-016z	2	Scheibe	Rondelle	Washer	Rondella	Skive	B19 nur Kawasaki
9	DA-180-214z	1	Schutz	Protecteur	Protection oder Cover	Protezione	Deksel	nur Honda
(10)	HI-040-026z	2	Niederhalter	Guide	Guide	Premicinghia	Holder	
11	HO-020-082z	9	Sechskantschraube	Vis à six pans	Hexagon bolt	Vite esagonale	Sekskantskrue	M 8 x 16
12	HO-020-085z	1	Sechskantschraube	Vis à six pans	Hexagon bolt	Vite esagonale	Sekskantskrue	M 8 x 30 nur Kawasaki, Yamaha
12	HO-090-302z	1	Zollschraube	Vis au pouce	Whitworth-bolt (-screw)	Vite in pollici	Skru	5/16" nur B&S
12	HO-020-083z	1	Sechskantschraube	Vis à six pans	Hexagon bolt	Vite esagonale	Sekskantskrue	M 8 x 20 nur Honda
13	HW-060-007z	1	Scheibe	Rondelle	Washer	Rondella	Skive	A 8,4
14	HT-010-008z	1	Federring	Bague de ressort	Spring washer	Anello elastico	Sprengskive	A 8,0
15	KH-010-005	1	Paßfeder	Ressort	Parallel key	Linguetta	Kile	nur Honda
15	KH-030-050	1	Zollpaßfeder	Ressort au pouce	Parallel key	Linguetta in pollici	Kile	nur B&S, Kawasaki
15	KH-010-001	1	Paßfeder	Ressort	Parallel key	Linguetta	Kile	nur Yamaha
16	HW-050-007z	19	Scheibe	Rondelle	Washer	Rondella	Skive	Ø 8,4
17	HO-010-088z	4	Sechskantschraube	Vis à six pans	Hexagon bolt	Vite esagonale	Sekskantskrue	M 8 x 45
18	HR-010-005z	6	Sechskantmutter	écrou à six pans	Hexagon nut	Dado esagonale	Sekskantmutter	M 8
19	HO-010-089z	1	Sechskantschraube	Vis à six pans	Hexagon bolt	Vite esagonale	Sekskantskrue	M 8 x 50
20	HO-020-054z	1	Sechskantschraube	Vis à six pans	Hexagon bolt	Vite esagonale	Sekskantskrue	M 6 x 16
21	HW-030-005z	2	Scheibe	Rondelle	Washer	Rondella	Skive	Ø 6,6
22	HR-030-004z	1	Sicherungsmutter	écrou de sûreté	Locknut	Dado autobloccante	Låsemutter	M 6
23	HO-020-053z	3	Sechskantschraube	Vis à six pans	Hexagon bolt	Vite esagonale	Sekskantskrue	M 6 x 12
24	HT-010-006z	3	Federring	Bague de ressort	Spring washer	Anello elastico	Sprengskive	
25	HW-010-007z	2	Scheibe	Rondelle	Washer	Rondella	Skive	B 8,4
26	HO-020-082z	2	Sechskantschraube	Vis à six pans	Hexagon bolt	Vite esagonale	Sekskantskrue	M 8 x 16 nur Honda
26	HO-090-300z	2	Zollschraube	Vis au pouce	Whitworth-bolt (-screw)	Vite in pollici	Skru	5/16" nur B&S, Kawasaki
(27)	HI-040-027z	2	Bügel	Bride	Handle	Staffa	Bøyle	
28	DA-200-676z	4	Klemmstück	Bride	Clamping piece	Particolare di bloccaggio	Klemmstykke	
29	HR-010-003z	8	Sechskantmutter	écrou à six pans	Hexagon nut	Dado esagonale	Sekskantmutter	M 5
30	HW-060-004z	4	Scheibe	Rondelle	Washer	Rondella	Skive	B 6,4
31	HJ-010-023	4	Hutstopfen	Bouchon	Cap	Tappo cieco		
32	DA-200-692	1	Eingriffschutz	Protecteur	Protector	Protezione	Deksel	

* Motore über die entsprechende Motorenvertretung beziehen!



16

Pos.-Nr. Rep. Pos. Pos. Bilde-Nr.	Bestellnummer Référence Article number Nr. codice Bestillings-Nr.	Anzahl Qté. Quant. Q.tà Antall	Bezeichnung 	Désignation 	Description 	Descrizione 	Benevnelse 	Bemerkungen
1	AA-270-102-9005	1	Taumelgehäuse	Boîtier excentrique	Reeling-housing	Scatola eccentrico	Svinghus	
2	DC-391-005	1	Taumelwelle	Arbre	Reeling-shaft	Albero obliquo	Eksenteraksel	
3	HA-030-008	2	Kugellager	Roulement à billes	Ball bearing	Cuscinetto a sfere	Kulelager	
4	HU-030-035	2	Seeger-L-Ring	Bague de sûreté	Circlip	Anello Seeger L	Låsering	
5	DA-240-393z	2	Scheibe	Rondelle	Washer	Rondella	Skive	
6	AA-250-101-9005	2	Flansch	Flasque	Flange	Flangia	Flens	
7	DC-131-039-9005	3	Distanzstück	Entretoise	Spacer	Distanziale	Distansestykke	
8	AZ-001-411-9005	1	Keilriemenscheibe	Poulie	V-belt pulley	Puleggia	Kileremskive	
9	HX-010-271	1	Spannstift	Goupille de serrage	Spring pin	Spina elastica	Spennstift	
10	HX-010-216	1	Spannstift	Goupille de serrage	Spring pin	Spina elastica	Spennstift	
11	KE-001-001z	1	Schmiernippel	Graisseur	Grease nipple	Ingrassatore	Smørenippel	
12	DV-261-001	1	Buchse	Coussinet	Bush	Boccola	Foring	
13	HJ-012-005	1	Dichtungskappe	Bouchon	Sealing cap	Coperchio tenuta	Støvkappe	
(14)	KC-001-002	1	Kugelmesserkopf	Tête à rotule	Cutter bar head	Testina sferica lama	Knivhode	
15	DX-003-001	1	Mitnehmer	Entraîneur	Drive pin	Trascinatore	Medbringer	
16	HU-030-030	1	Sicherungsring	Anneau d'arrêt	Retaining ring	Seger	Semering	
17	DA-181-009-9005	1	Abweiser	Défecteur	Repeller	Spartierba	Avviser	
18	HO-026-083z	2	Sechskantschraube	Vis à six pans	Hexagon bolt	Vite esagonale	Sekskantskrue	M 8 x 20
19	HT-010-008z	2	Federring	Bague de ressort	Spring washer	Anello elastico	Sprenskive	
20	HW-060-007z	2	Scheibe	Rondelle	Washer	Rondella	Skive	A 8,4
21	KD-003-023	1	Folienkleber	Autocollant	Lable	Autoadesivo	Dekal	
22	AZ-004-058	1	Kugelmesserkopf	Tête à rotule	Cutter bar head	Testina sferica lama	Knivhode	